

3120-F321-H7T1-W19DG4-20A



Obrázky jsou pouze orientační.
Podrobné informace o produktu naleznete v části Technické údaje produktu.

Koupit 3120-F321-H7T1-W19DG4-20A s důvěrou od Component-World.HK, 1 rok záruka



Part Number: [3120-F321-H7T1-W19DG4-20A](#)

Výrobce: [E-T-A](#)

Popis: CIR BRKR THRM 20A 250VAC 50VDC

Datový list:  [3120-F Series Datasheet](#)

RoHS Status: Bez olova / V souladu RoHS

Ship From: Hong Kong

Shipment Way: DHL/Fedex/TNT/UPS/EMS

[Request For Quotation](#)









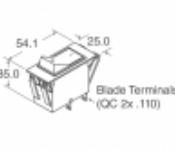
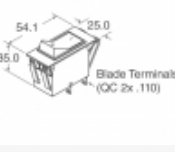

PARAMETR PRODUKTU

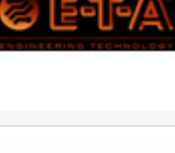
Part Number	3120-F321-H7T1-W19DG4-20A	Výrobce	E-T-A
Popis	CIR BRKR THRM 20A 250VAC 50VDC	Stav volného vedení / RoHS	Bez olova / V souladu RoHS
Dostupné množství	2002 pcs	Datový list	3120-F Series Datasheet
Kategorie	Ochrana obvodu	Napití - DC	50V
Napití - AC	250V	Série	3120-F
Počet pólů	2	Typ montáže	Panel Mount
Úroveň citlivosti na vlhkost (MSL)	1 (Unlimited)	Výrobní standardní doba výroby	9 Weeks
Stav volného vedení / RoHS	Lead free / RoHS Compliant	Osvětlení napětí (nominální)	185V
Osvětlení	Green	Jmenovitá hodnota proudu	20A
Breaker Typ	Thermal	Pohon Type	Rocker

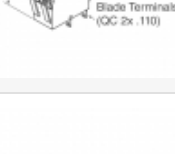
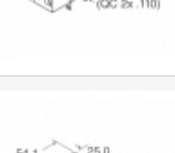
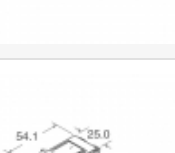
Component-World.com je spolehlivý distributor elektronických součástek. Specializujeme se na všechny elektronické komponenty řady E-T-A. Máme 2002 kusy E-T-A 3120-F321-H7T1-W19DG4-20A na skladě dostupných. Vyžádejte si citát z distributora součástí elektroniky na Component-World.com, náš prodejní tým vás bude kontaktovat do 24 hodin.

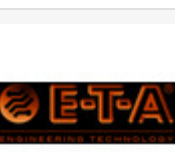
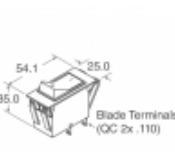
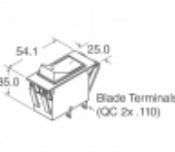
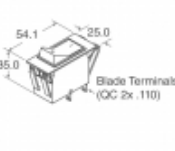
RFQ Email: info@Components-World.com

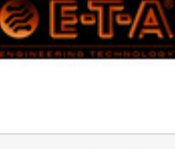
SOUVISEJÍCÍ PRODUKTY

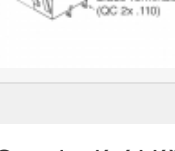
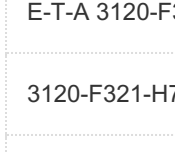
	Část#: 3120-F321-H7T1-W15FY3-5A Popis: CIR BRKR THRM 5A	Výrobci: E-T-A	Dotaz
	Část#: 3120-F321-H7T1-W15AY3-10A Popis: CIR BRKR THRM 10A 250VAC 50VDC	Výrobci: E-T-A	Dotaz
	Část#: 3120-F321-H7T1-W14XR4-1A Popis: CIR BRKR THRM 1A 250VAC 50VDC	Výrobci: E-T-A	Dotaz
	Část#: 3120-F321-P7M1-W01A-2.5A Popis: CIRC BRKR THRM	Výrobci: E-T-A	Dotaz
	Část#: 3120-F321-H7T1-W14FR3-X3120-U0001M-10A Popis: CIR BRKR THRM 10A 250VAC 50VDC	Výrobci: E-T-A	Dotaz
	Část#: 3120-F321-H7T1-W14FR3-X3120-U0001M-16A Popis: CIR BRKR THRM 16A 250VAC 50VDC	Výrobci: E-T-A	Dotaz
	Část#: 3120-F321-H7T1-W19LG3-15A Popis: CIR BRKR THRM 15A 250VAC 50VDC	Výrobci: E-T-A	Dotaz
	Část#: 3120-F321-P7T1-M01G-2.5A Popis: CIR BRKR THRM 2.5A 250VAC 50VDC	Výrobci: E-T-A	Dotaz
	Část#: 3120-F321-P7M1-W01X-15A Popis: CIR BRKR THRM 15A 250VAC 50VDC	Výrobci: E-T-A	Dotaz
	Část#: 3120-F321-H7T1-W19DG4-8A Popis: CIR BRKR THRM 8A 250VAC 50VDC	Výrobci: E-T-A	Dotaz
	Část#: 3120-F321-P7M1-W19DG2-16A Popis: CIR BRKR THRM 16A 250VAC 50VDC	Výrobci: E-T-A	Dotaz
	Část#: 3120-F321-H7T1-W19DG4-5A Popis: CIRC BRKR THRM	Výrobci: E-T-A	Dotaz
	Část#: 3120-F321-H7T1-W14XR4-X3120-U0000M-1A Popis: CIR BRKR THRM 1A 250VAC 50VDC	Výrobci: E-T-A	Dotaz
	Část#: 3120-F321-H7T1-W19LG3-X3120-U0001M-20A Popis: CIR BRKR THRM 20A 250VAC 50VDC	Výrobci: E-T-A	Dotaz
	Část#: 3120-F321-H7T1-W19LB3-10A Popis: CIR BRKR THRM 10A 250VAC 50VDC	Výrobci: E-T-A	Dotaz
	Část#: 3120-F321-H7T1-W15AY4-5A Popis: CIR BRKR THRM 5A 250VAC 50VDC	Výrobci: E-T-A	Dotaz
	Část#: 3120-F321-H7T1-W19DG2-5A Popis: CIRC BRKR THRM	Výrobci: E-T-A	Dotaz
	Část#: 3120-F321-H7T1-W15FY1-6A Popis: CIR BRKR THRM 6A 250VAC 50VDC	Výrobci: E-T-A	Dotaz
	Část#: 3120-F321-H7T1-W19LG3-X3120-U0001M-10A Popis: CIR BRKR THRM 10A	Výrobci: E-T-A	Dotaz
	Část#: 3120-F321-H7T1-W19DG4-15A Popis: CIR BRKR THRM 15A	Výrobci: E-T-A	Dotaz

Související klíčová slova pro 3120-F321-H7T1-W19DG4-20A

E-T-A 3120-F321-H7T1-W19DG4-20A.	3120-F321-H7T1-W19DG4-20A distributor	3120-F321-H7T1-W19DG4-20A dodavatel	3120-F321-H7T1-W19DG4-20A Cena
3120-F321-H7T1-W19DG4-20A Stáhnout datasheet.	3120-F321-H7T1-W19DG4-20A Datasheet.	3120-F321-H7T1-W19DG4-20A Stock.	koupit 3120-F321-H7T1-W19DG4-20A.
E-T-A 3120-F321-H7T1-W19DG4-20A.			